

Technical News Bulletin

St. Petersburg, May 2017



Application Notes – MiniLab Configurations

- A turnkey solution for statistical sampling quality control of glass containers.
- Flexible and scalable design lets glass container manufacturers integrate multiple devices.
- All MiniLab come standard with hardware and software to communicate with a Factory Information System

Introduction

MiniLab is a turnkey solution for statistical sampling quality control of glass containers. It not only ensures adherence to critical quality criteria but also improves the frequency and efficiency of the time-consuming quality control tests. MiniLab's flexible and scalable design lets glass container manufacturers integrate multiple devices to serve specific quality control requirements.

This document describes the most commonly used MiniLab configurations. The configuration depends on many factors, some of which are listed below.

- Quality control requirements
- Type of containers measured
- Installation on the factory floor or in the quality control lab
- Semi automatic or fully automatic operation

2. MiniLab Components

2.1. MiniLab D Dimensional Gauging and Weight Measurement System

MiniLab D uses high-resolution cameras and application specific optics to measure various dimensional characteristics of glass containers including glass thickness.

Containers enter the machine, are measured, and exit the machine to an accumulation conveyor or to the next machine on the MiniLab.

MiniLab D measures containers of different sizes without requiring a job change.



2.2. MiniLab P Pressure Tester and Capacity Measurement System

MiniLab P measures the maximum amount of internal pressure a container can withstand in conformance with the ASTM C147 standard for internal pressure testing of glass containers.

In addition, **MiniLab P** can be equipped with a Capacity Gauge. When equipped with this option **MiniLab P** accurately measures the capacity of a container at several fill heights and overflow. The system automatically compensates for variation in water temperature and flow rate.

Containers enter the machine, are lifted to the carousel and clamped at the neck, filled with water (optional capacity measurement is performed during the fill process), pressure tested, and then released to the cullet conveyor under the machine.

MiniLab P measures containers of different sizes (with same finish size) without requiring a job change. Job change parts are minimal and a complete changeover does not require any mechanical adjustment.



2.3. Host Communication Interface

All MiniLab come standard with hardware and software to communicate with a Factory Information System as defined in the document MiniLab Host Communication Specification. After each container is measured all measurement values are sent to the Factory Information System for archive and further analysis.

2.4. Conveyor

Emhart Glass can supply the entire conveyor with MiniLab in the Off-Line configuration. For MiniLab in the Automatic Sampling configuration, Emhart Glass only supplies the straight conveyor going through the machines. The customer is responsible for the conveyor from the manufacturing line to the MiniLab.

Of course, with all MiniLab configurations the customer can always supply the entire conveyor according to a mutually-agreed conveyor configuration.

Emhart Glass always supplies the necessary gates and sensors to control the flow and to track the containers on the MiniLab conveyor.

2.5. Power Distribution Assembly

The Power Distribution assembly provides power and control for the conveyor motors. It is used to start & stop the conveyor and provides E-stop operation.

The Power Distribution Assembly is supplied with the Emhart Glass conveyor.

Utility Requirements

NOTE: *The customer is responsible for providing a stable, clean power supply to the MiniLab. Power fluctuations (high or low voltage conditions) can cause MiniLab components to shut down and/or stop unexpectedly, as well as damage electronic components.*

- **Power:** 220/240 VAC, Single Phase 50/60 Hertz, 20 amps (separate power drops are required for the **MiniLab D**, **MiniLab P**, and Power Distribution Assembly).
- **Air:** 3.45 to 6.21 bar at 0.61 m² per minute [50 to 90 psi at 2 cfm] (clean, oil-free).
- **Water (only required if MiniLab P is present):** **MiniLab P** is designed to operate at ambient temperatures of 2 to 50°C [38 to 122°F]. The temperature of supply water must not fluctuate more than ±1.6°C [± 3°F] during the test of a container. Water-freezing temperatures must be avoided or serious damage will occur to machine components. Water must come from a dedicated source. **MiniLab P** should not share water with other devices in the plant that would lower the water pressure to the machine. Loss of pressure will affect the accuracy and reliability of the capacity measurements and the pressure tests.
Water Pressure: 2.4 to 4.14 bar (35 to 60 psi) 15 liter/min (4 GPM) average.
- **Relative Humidity** 95% (non-condensing).
- **Ambient Temperature:** 3.3° to 50°C [38° to 122°F].

3. MiniLab Configurations

The following section depicts concept drawings for some of the most commonly used MiniLab configurations:

- Off-Line – Single infeed conveyor
- Off-Line – Dual infeed conveyor
- Automatic Sampling

A MiniLab in the Off-Line configuration offers semi-automatic operation with the operator manually placing the containers on one or more infeed conveyors. In comparison, a MiniLab in the Automatic Sampling configuration offers fully automatic operation with no operator intervention.

All MiniLab configurations accommodate pressure and non-pressure containers. Depending on the configuration, containers not designated for pressure testing or capacity measurement are either disposed of in **MiniLab P** or returned to a conveyor (or accumulation table).

3.1 Off-Line – Single infeed conveyor

This section describes a configuration with only one infeed conveyor. Containers are manually placed on the infeed conveyor and the mold numbers are manually entered in the sequence to be tested. When starting the test, the operator specifies the type of containers being measured.

In this configuration, the MiniLab can be shared between several manufacturing lines. The infeed gates are manually adjusted for containers of different diameters.

This configuration is usually installed on the factory floor or in the quality control area.

3.1.1 Off-Line – MiniLab P – Single infeed conveyor

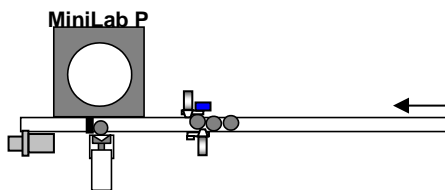

3.1.2 Off-Line – MiniLab D – Single infeed conveyor

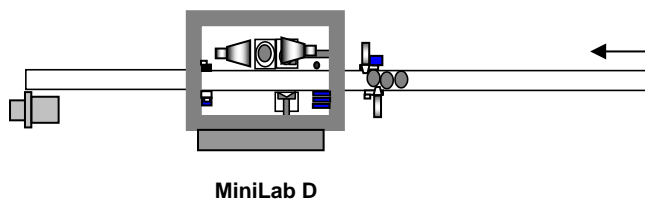

3.1.3 Off-Line – MiniLab D – U conveyor

Same operation as the configuration above but with a slightly different conveyor layout.

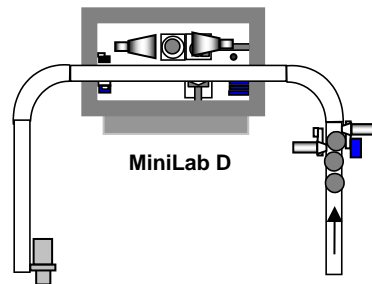

3.1.4 Off-Line – MiniLab D and MiniLab P – Single infeed conveyor

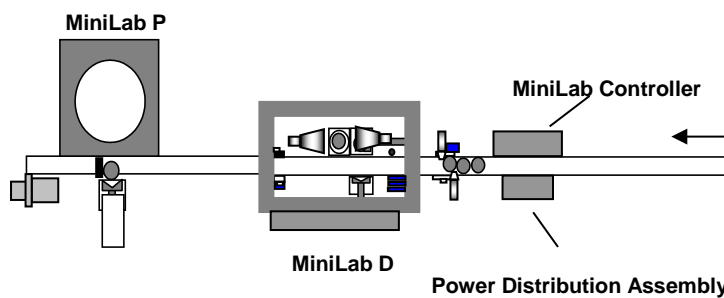

3.2 Off-Line - Dual Infeed Conveyor

This section describes a configuration with two infeed conveyors. Containers are manually placed on the infeed conveyors and the mold numbers are manually entered in the sequence to be tested. Two different sets of containers from two different manufacturing lines with different product types can be measured at the same time.

In this configuration, the MiniLab can be shared between several manufacturing lines. The infeed gates are manually adjusted for containers of different diameters.

This configuration is usually installed on the factory floor or in the quality control area.

3.2.1 Off-Line – MiniLab P – Dual infeed conveyor

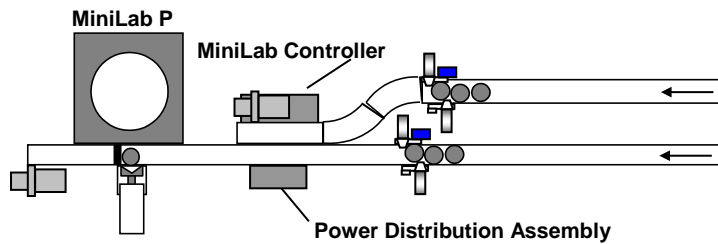

3.2.2 Off-Line – MiniLab D – Dual infeed conveyor

Note: Accumulation Area should be sized to handle both lines.

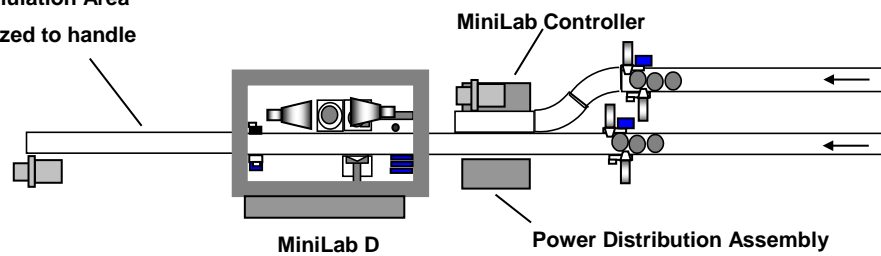

3.2.3 Off-Line – MiniLab D – Dual infeed – Dual outfeed conveyor

Containers from infeed conveyor A are returned to outfeed conveyor A
Containers from infeed conveyor B are returned to outfeed conveyor B

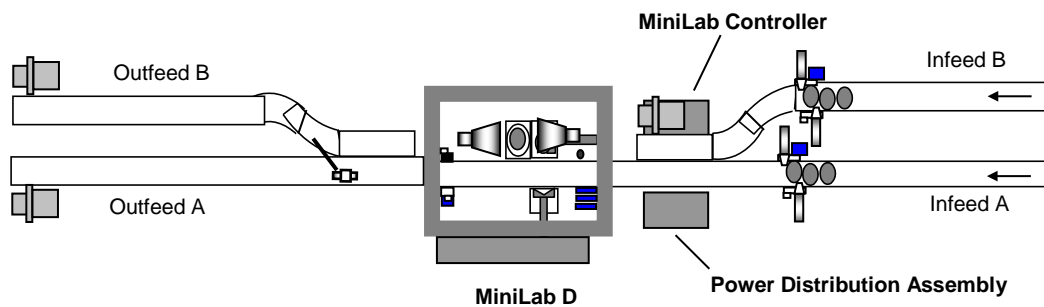

3.2.4 Off-Line – MiniLab D and MiniLab P – Dual infeed conveyor

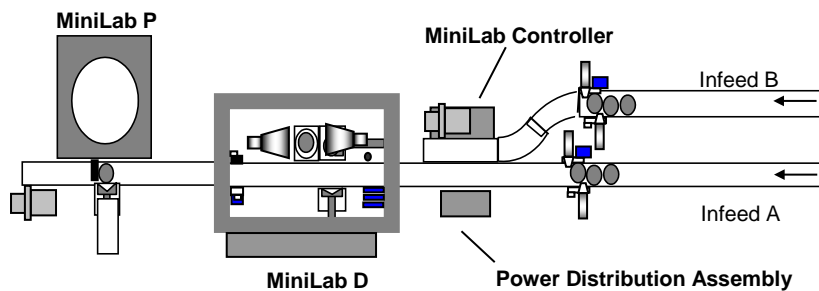

Automatic Sampling

This section describes configurations in which containers are automatically diverted to the MiniLab from the manufacturing line for a fully automatic operation without any operator intervention. This configuration relies on existing on-line inspection equipment with mold reading capability to divert containers to the MiniLab.

This configuration is installed on the factory floor.

Note: Emhart Glass can supply the straight conveyor going through the measurement machines. The customer is responsible for the conveyor from the manufacturing line to the MiniLab. The customer can also supply the entire conveyor according to a mutually-agreed configuration.

3.3.1 Automatic Sampling – Single infeed conveyor

In this configuration the MiniLab is connected to one manufacturing line. It accommodates pressure and non-pressure containers. All containers are disposed of in **MiniLab P**.

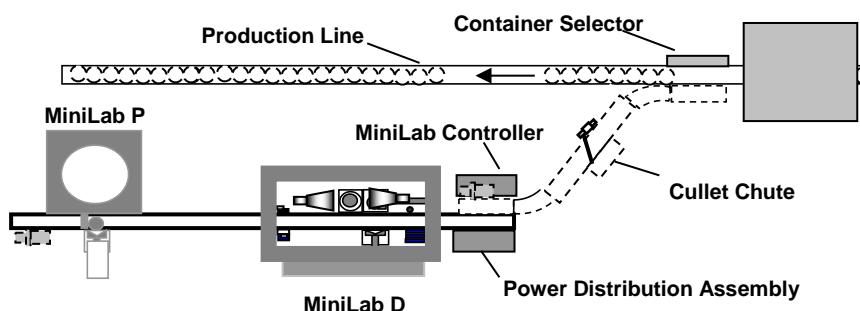

3.3.2 Automatic Sampling – Single infeed conveyor with return

In this configuration the MiniLab is connected to one manufacturing line. It accommodates pressure and non-pressure containers. Containers not designated for pressure testing or capacity measurement are returned to the return conveyor or to an accumulation table.

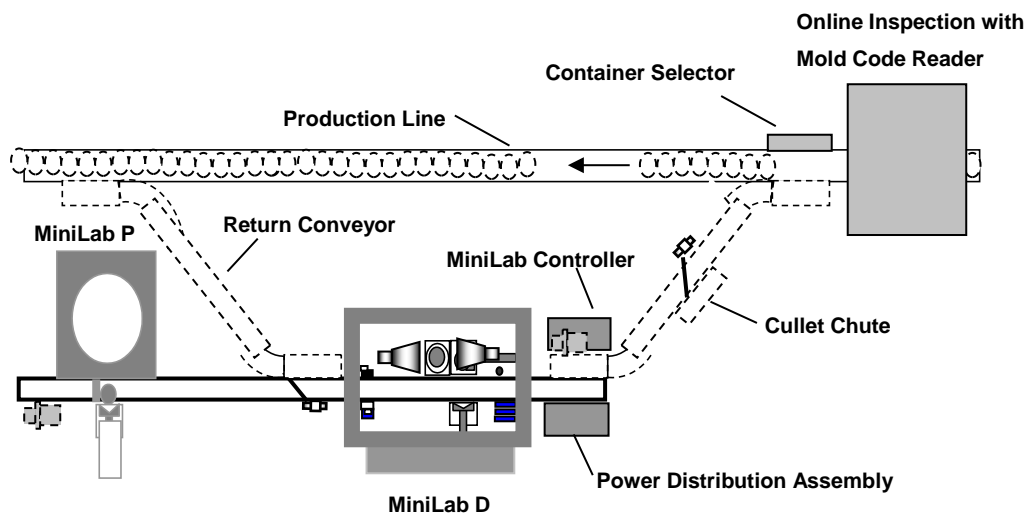

3.3.3 Automatic Sampling – Dual infeed conveyors

In this configuration the MiniLab is connected to two manufacturing lines allowing two different product types to be measured at the same time. This configuration accommodates pressure and non-pressure containers. All containers are disposed of in **MiniLab P**.

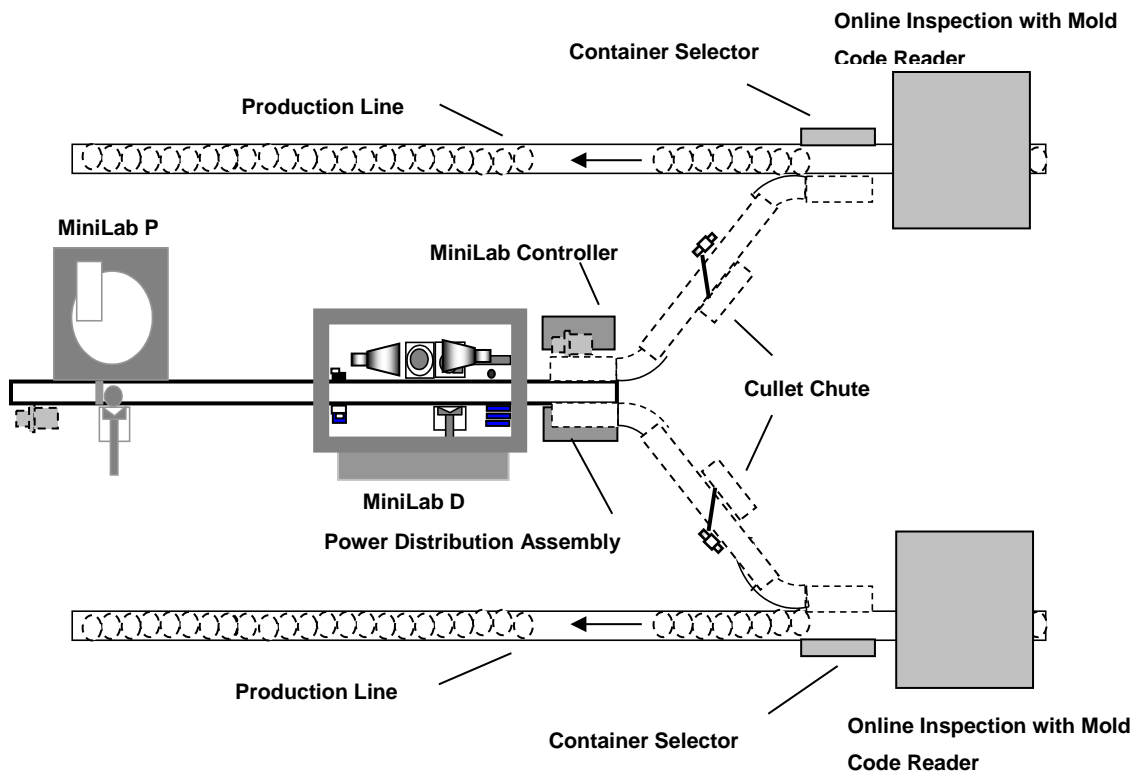

3.3.4 Automatic Sampling – Dual infeed conveyors with returns

In this configuration the MiniLab is connected to two manufacturing lines allowing two different product types to be measured at the same time. This configuration accommodates pressure and non-pressure containers. Containers not designated for pressure testing or capacity measurement are returned to the corresponding return conveyor or to an accumulation table.

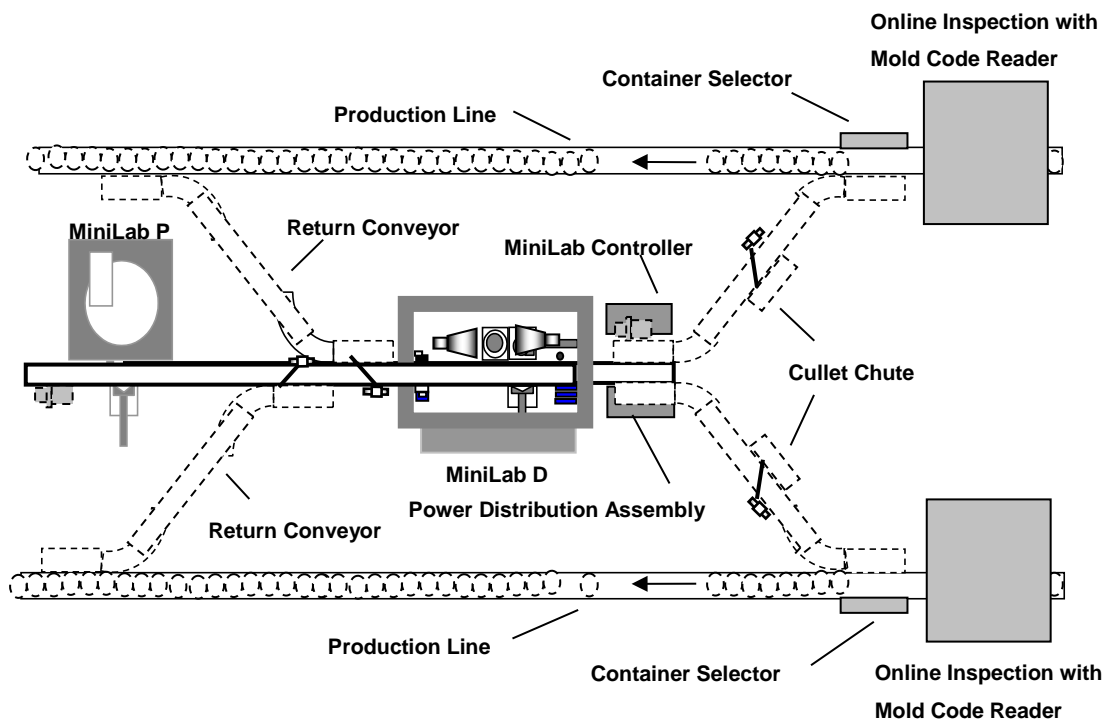

3.3.5 Automatic Sampling – Hybrid

In this configuration the MiniLab is connected to one manufacturing line. A second infeed conveyor offers the flexibility to measure containers from the other manufacturing lines. This configuration accommodates pressure and non-pressure containers. All containers are disposed of in **MiniLab P**.

The Automatic Sampling is automatically put on hold when the Manual Sampling side is in use. Containers are manually placed on the Manual Sampling infeed conveyor and the mold numbers are manually entered in the sequence to be tested. The Manual Sampling infeed conveyor can be shared between several manufacturing lines.

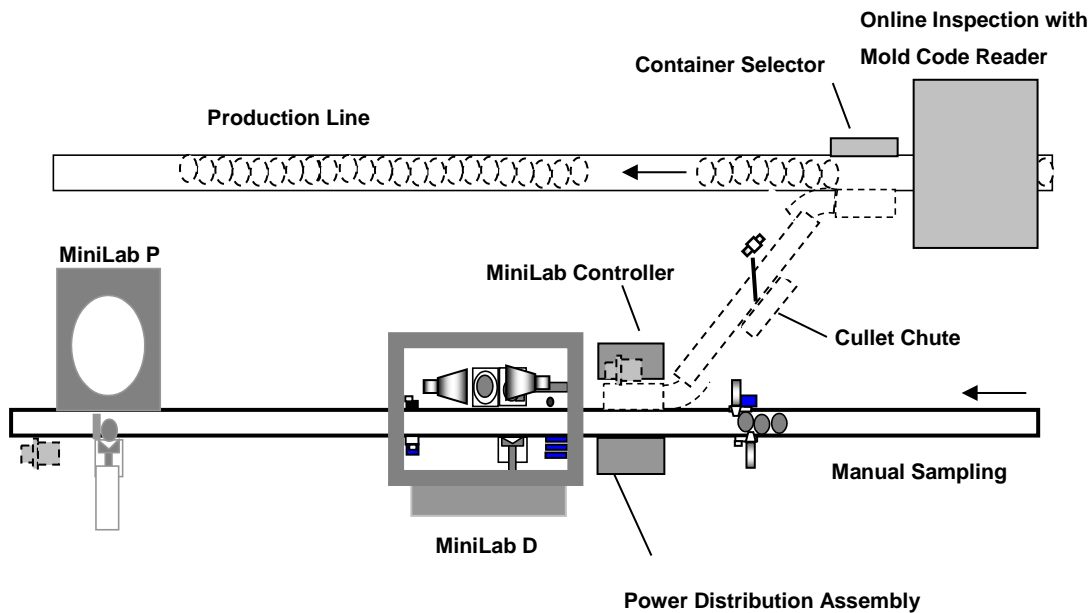

3.3.6 Automatic Sampling – Hybrid with return

In this configuration the MiniLab is connected to one manufacturing line. A second infeed conveyor offers the flexibility to measure containers from the other manufacturing lines. This configuration accommodates pressure and non-pressure containers. Containers not designated for pressure testing or capacity measurement are returned to the return conveyor or to an accumulation table.

The Automatic Sampling is automatically put on hold when the Manual Sampling side is in use. Containers are manually placed on the Manual Sampling infeed conveyor and the mold numbers are manually entered in the sequence to be tested. The Manual Sampling infeed conveyor can be shared between several manufacturing lines.

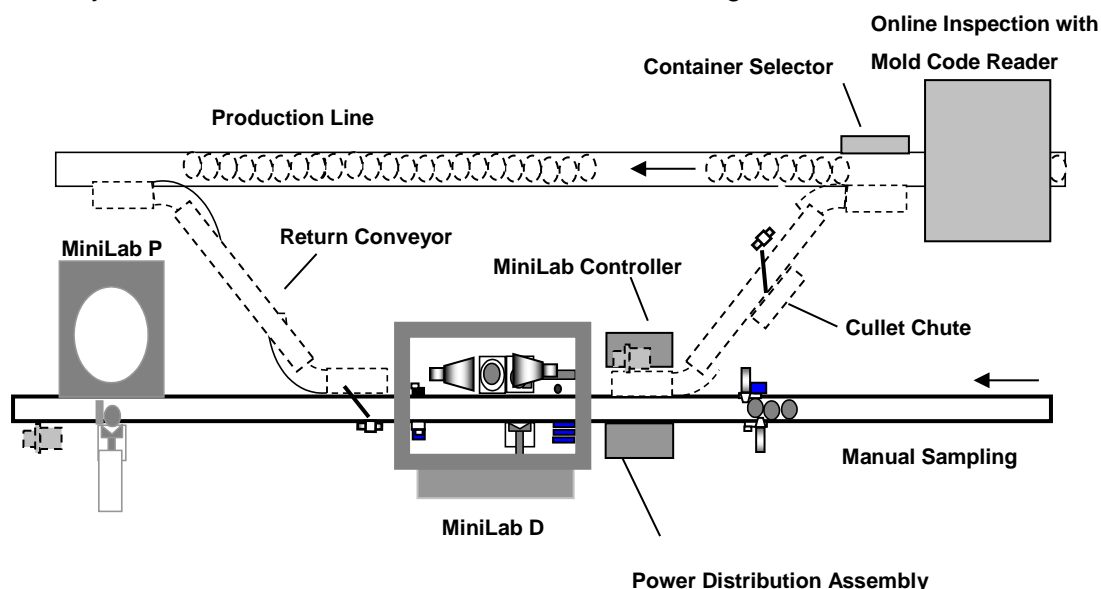

Revisions		
G	8 May 2017	Removed Mold Code Reader and Data Collector.
F	14 April 2015	Updated to reflect machines name change
E	20 June 2012	Updated components description. Updated layout configurations. Updated all pictures.
D	30 Mar 2011	All references to Emhart Inex changed to Emhart Glass. Added FleX T and BC to list of machines under MiniLab Controller Sampling Controller module. Replaced "MiniLab Data Collector Kit" with "Data Collection" (included completely new content). Added Utility Requirements section.
C	14 Feb 2008	Sec. 3: Added MiniLab Sampling Controller and MiniLab Data Collection Kit
B	27 July 2007	Added ASTM C147 standard information to MLP description
A	2 May 2007	Corrected typographical errors, fixed layout problems